

AQUATEK spol. s r. o. Topolčany

MASTER S7

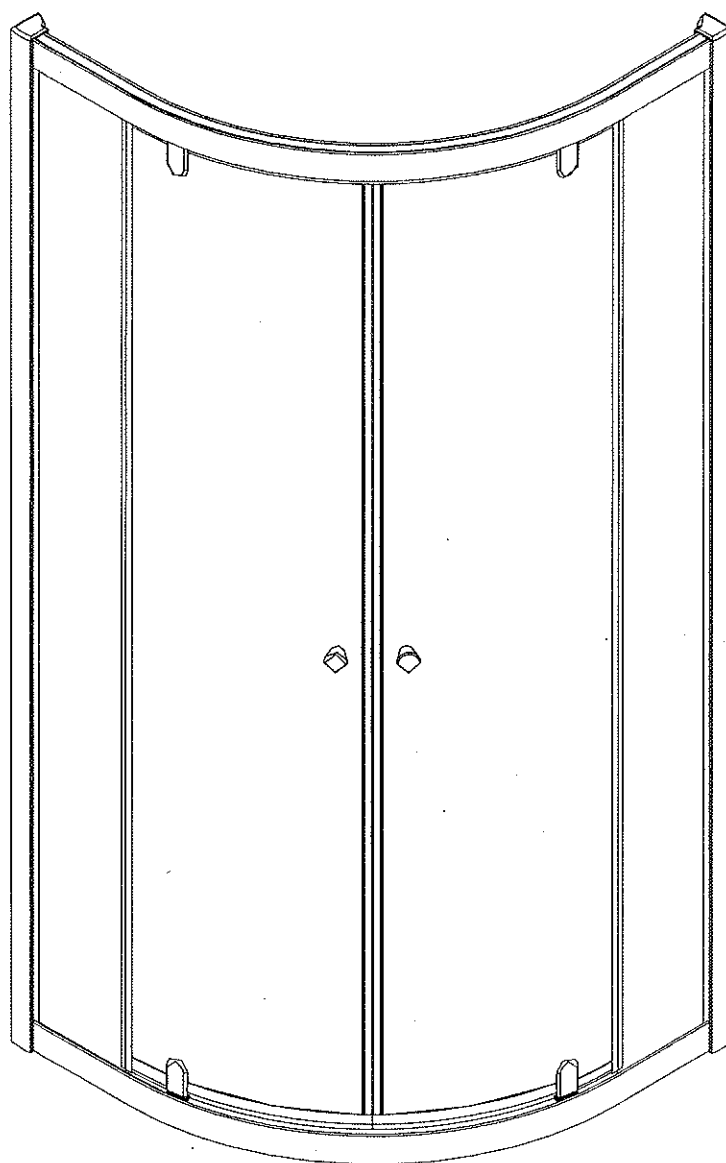

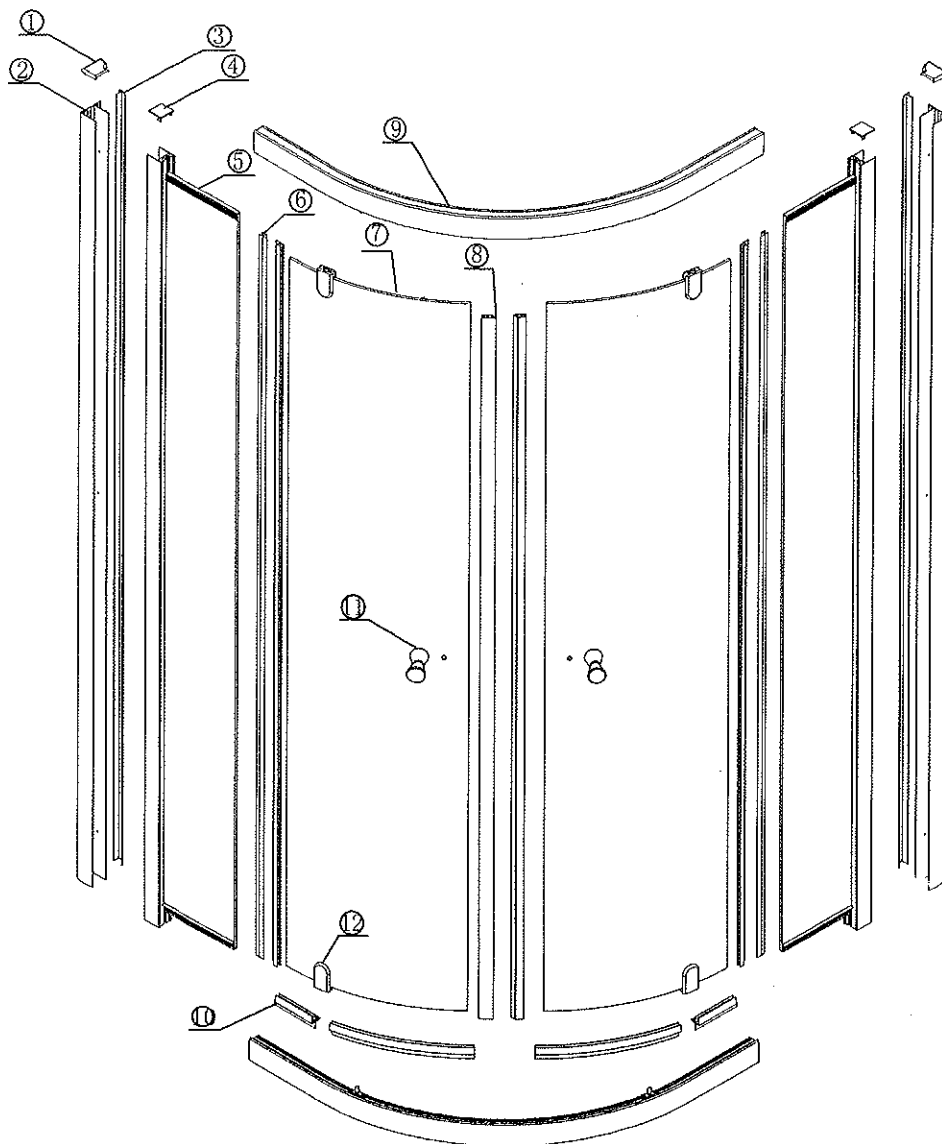

- | | | | | | | |
|--------------------------|------------------------|--------------|--------------|--------------|-----------------------|----------------------|
| <p>① x 2
L&R</p> | <p>② x 2</p> | <p>③ x 2</p> | <p>④ x 2</p> | <p>⑤ x 2</p> | <p>⑥ x 4</p> | <p>⑦ x 2</p> |
| <p>⑧ x 2</p> | <p>⑨ x 2</p> | <p>⑩ x 4</p> | <p>⑪ x 2</p> | <p>⑫ x 4</p> | <p>x 8
ST4X30</p> | <p>x 6
Ø8X30</p> |
| <p>x 6
ST5X30</p> | <p>x 12
ST4X15</p> | | | | | |



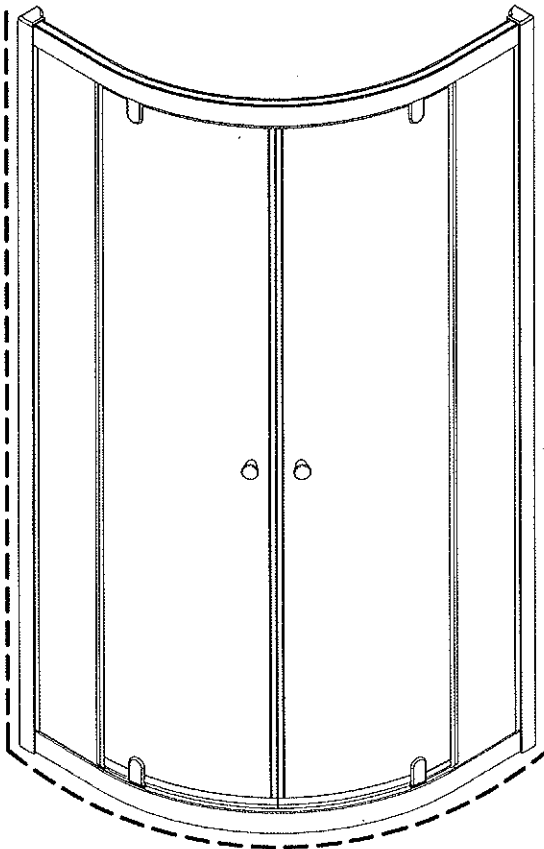
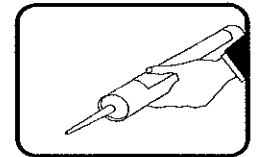
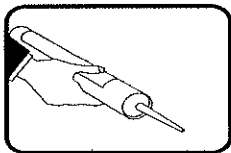
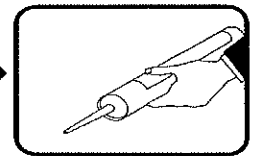
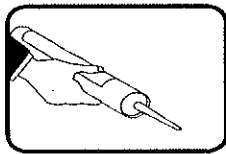
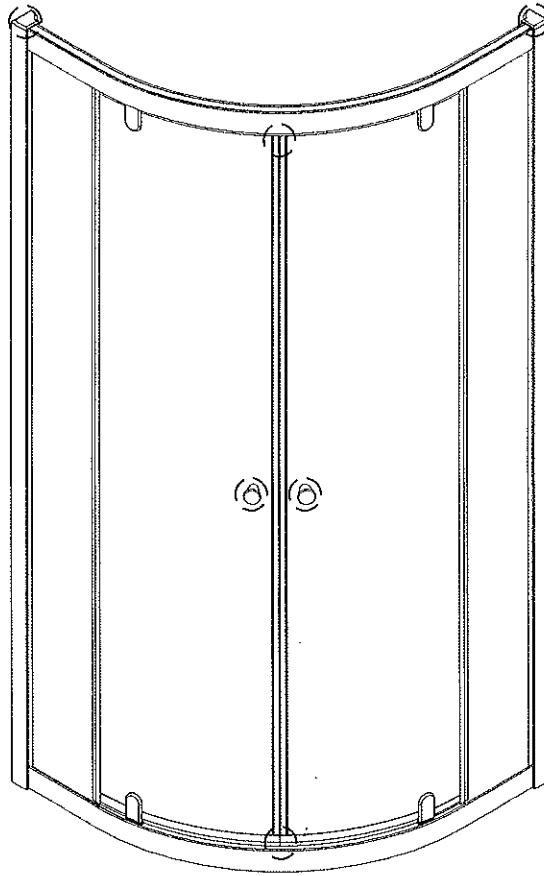
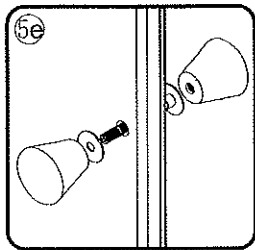
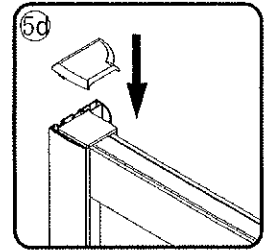
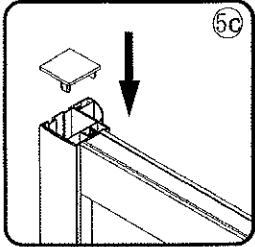
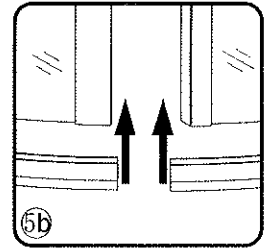
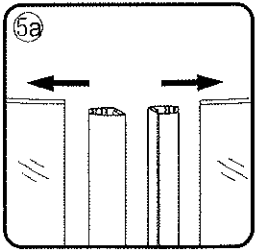

Montážny návod

Pomocné náradie používané pri montáži sprchovacieho kúta :

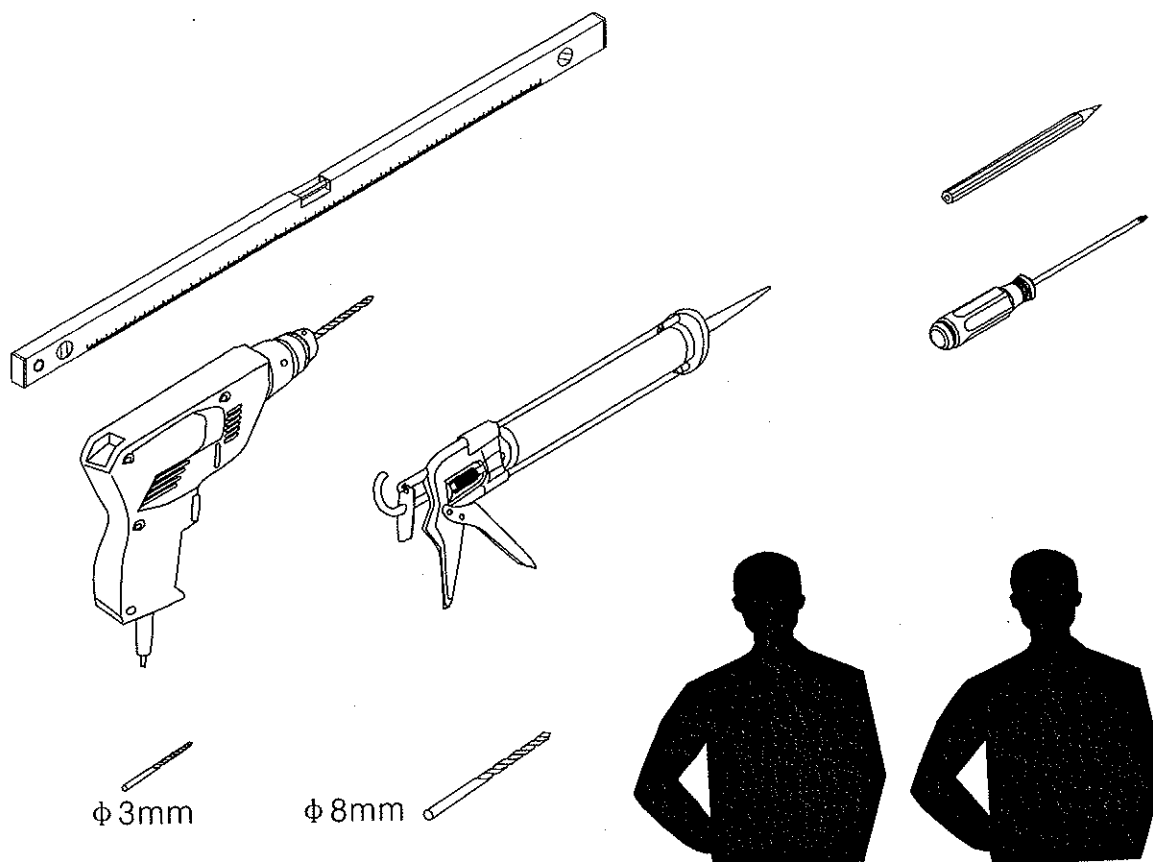

Upozornenie : utesniť silikónom len z vonkajšej strany.

Upozornenie : k montáži sprchovacieho kúta sú potrebné 2 osoby.